

User Manual

1K-5K OFF GRID SOLAR INVERTER

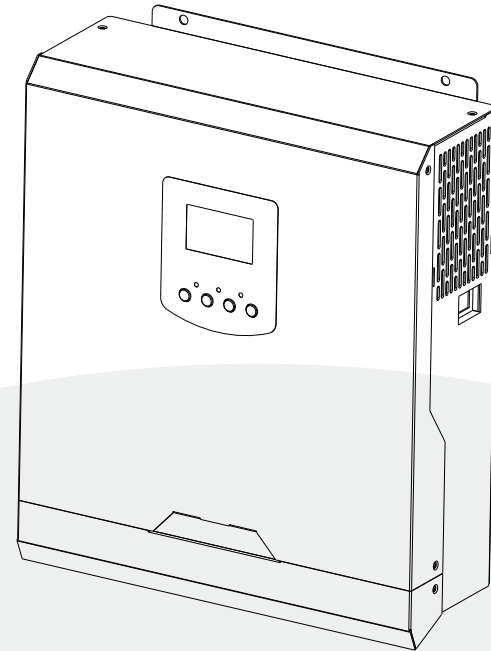

Table Of Contents

ABOUT THIS MANUAL	1
Purpose	1
Scope	1
SAFETY INSTRUCTIONS	1
INTRODUCTION	2
Features	2
Basic System Architecture	2
Product Overview	3
INSTALLATION	4
Unpacking and Inspection	4
Preparation	4
Mounting the Unit	4
Battery Connection	5
AC Input/Output Connection	7
PV Connection	9
Final Assembly	12
Communication Connection	12
OPERATION	13
Power ON/OFF	13
Operation and Display Panel	13
LCD Display Icons	14
LCD Setting	16
Display Setting	24
Operating Mode Description	28
Battery Equalization Description	30
Fault Reference Code	32
Warning Indicator	32
SPECIFICATIONS	33
Table 1 Line Mode Specifications	32
Table 2 Inverter Mode Specifications	33
Table 3 Charge Mode Specifications	34
Table 4 General Specifications	35
TROUBLE SHOOTING	35

ABOUT THIS MANUAL

Purpose

This manual describes the assembly, installation, operation and troubleshooting of this unit. Please read this manual carefully before installations and operations. Keep this manual for future reference.

Scope

This manual provides safety and installation guidelines as well as information on tools and wiring.

SAFETY INSTRUCTIONS



WARNING: This chapter contains important safety and operating instructions. Read and keep this manual for future reference.

- 1.Before using the unit, read all instructions and cautionary markings on the unit, the batteries and all appropriate sections of this manual.
- 2.CAUTION --To reduce risk of injury, charge only deep-cycle lead acid type rechargeable batteries.
Other types of batteries may burst, causing personal injury and damage.
- 3.Do not disassemble the unit. Take it to a qualified service center when service or repair is required.Incorrect re-assembly may result in a risk of electric shock or fire.
- 4.To reduce risk of electric shock, disconnect all wirings before attempting any maintenance or cleaning.Turning off the unit will not reduce this risk.
- 5.CAUTION – Only qualified personnel can install this device with battery.
- 6.NEVER charge a frozen battery.
- 7.For optimum operation of this inverter/charger, please follow required spec to select appropriate cable size. It's very important to correctly operate this inverter/charger.
- 8.Be very cautious when working with metal tools on or around batteries. A potential risk exists to drop a tool to spark or short circuit batteries or other electrical parts and could cause an explosion.
- 9.Please strictly follow installation procedure when you want to disconnect AC or DC terminals. Please refer to INSTALLATION section of this manual for the details.
- 10.One piece of 150A fuse is provided as over-current protection for the battery supply.
- 11.GROUNDING INSTRUCTIONS -This inverter/charger should be connected to a permanent grounded wiring system. Be sure to comply with local requirements and regulation to install this inverter.
- 12.NEVER cause AC output and DC input short circuited. Do NOT connect to the mains when DC input short circuits.
- 13.Warning!! Only qualified service persons are able to service this device. If errors still persist after following troubleshooting table, please send this inverter/charger back to local dealer or service center for maintenance.

INTRODUCTION

This is a multi-function inverter/charger, combining functions of inverter, solar charger and battery charger to offer uninterruptible power support with portable size. Its comprehensive LCD display offers user-configurable and easy-accessible button operation such as battery charging current, AC/solar charger priority, and acceptable input voltage based on different applications.

There are two different types of built-in solar chargers: PWM and MPPT solar charger. For the detailed product specification, please consult your local dealers.

Features

- Pure sine wave inverter
- Configurable input voltage range for home appliances and personal computers via LCD setting
- Configurable battery charging current based on applications via LCD setting
- Configurable AC/Solar Charger priority via LCD setting
- Compatible to mains voltage or generator power
- Auto restart while AC is recovering
- Overload/ Over temperature/ short circuit protection
- Smart battery charger design for optimized battery performance
- Cold start function

Basic System Architecture

The following illustration shows basic application for this inverter/charger. It also includes following devices to have a complete running system:

- Generator or Utility.
- PV modules

Consult with your system integrator for other possible system architectures depending on your requirements.

This inverter can power all kinds of appliances in home or office environment, including motor-type appliances such as tube light, fan, refrigerator and air conditioner.

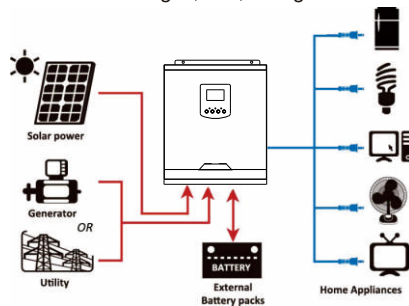
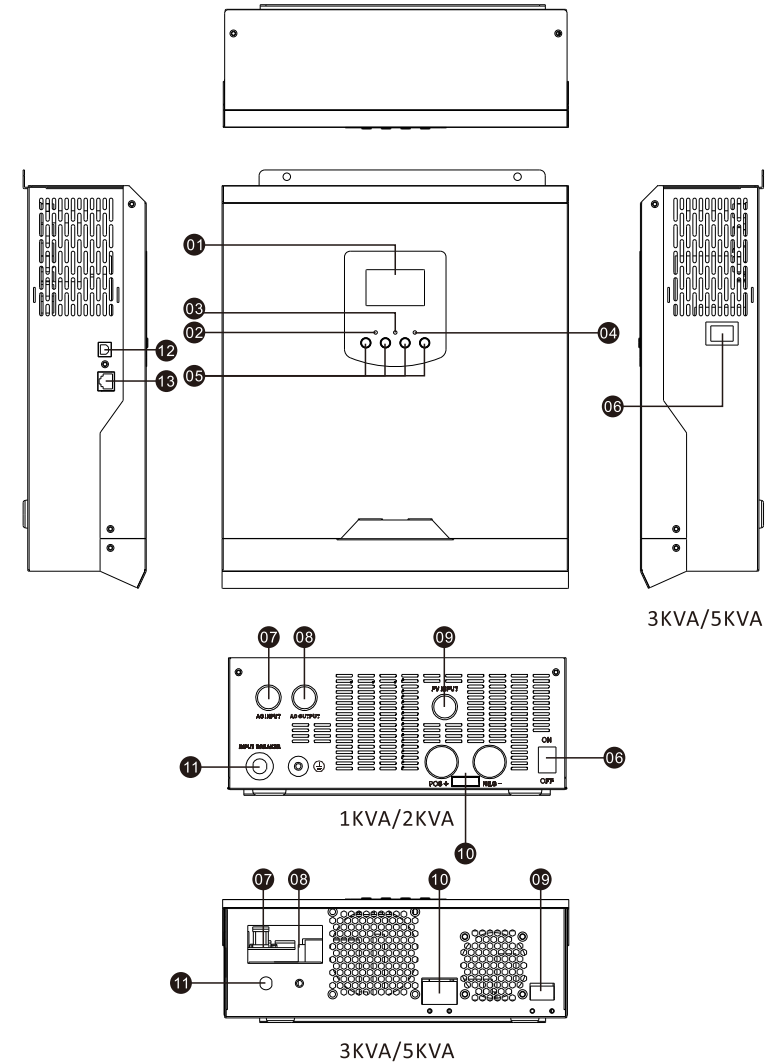

Figure 1 Hybrid Power System

Product Overview



- | | |
|-----------------------|------------------------------|
| 1.LCD display | 8.AC output |
| 2.Status indicator | 9.PV input |
| 3.Charging indicator | 10.Battery input |
| 4.Fault indicator | 11.Circuit breaker |
| 5.Function buttons | 12.USB communication port |
| 6.Power on/off switch | 13.RS-232 communication port |
| 7.AC input | |

INSTALLATION

Unpacking and Inspection

Before installation, please inspect the unit. Be sure that nothing inside the package is damaged. You should have received the following items inside of package:

- The unit x 1
- User manual x 1
- Communication cable x 1
- Software CD x 1 (Optional)
- DC Fuse x 1 (Optional)
- Ring terminal x 1 (Optional)
- Strain relief plate x 2 (Optional)
- Screws x 4 (Optional)

Preparation

Before connecting all wirings, please take off bottom cover by removing two screws as shown below.

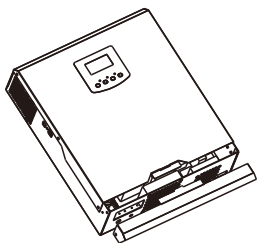

Mounting the Unit

Consider the following points before selecting where to install:

- Do not mount the inverter on flammable construction materials.
- Mount on a solid surface
- Install this inverter at eye level in order to allow the LCD display to be read at all times.
- For proper air circulation to dissipate heat, allow a clearance of approx. 20 cm to the side and approx. 50 cm above and below the unit.
- The ambient temperature should be between 0°C and 55°C to ensure optimal operation.
- The recommended installation position is to be adhered to the wall vertically.
- Be sure to keep other objects and surfaces as shown in the diagram to guarantee sufficient heat dissipation and to have enough space for removing wires.

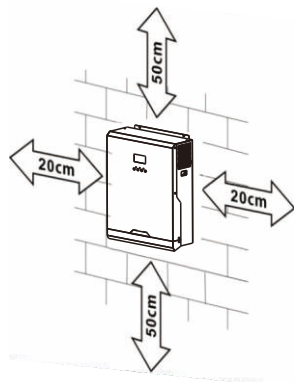

SUITABLE FOR MOUNTING ON CONCRETE OR OTHER NON-COMBUSTIBLE SURFACE ONLY.

Install the unit by screwing two screws. It's recommended to use M4 or M5 screws.

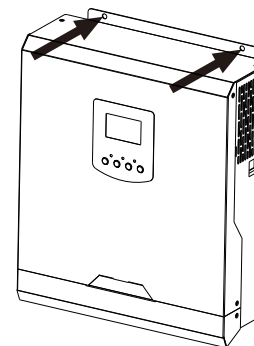

Battery Connection

CAUTION: For safety operation and regulation compliance, it's requested to install a separate DC over-current protector or disconnect device between battery and inverter. It may not be requested to have a disconnect device in some applications, however, it's still requested to have over-current protection installed. Please refer to typical amperage in below table as required fuse or breaker size.

WARNING! All wiring must be performed by a qualified personnel.

WARNING! It's very important for system safety and efficient operation to use appropriate cable for battery connection. To reduce risk of injury, please use the proper recommended cable as below.

Recommended battery cable size:

Model	Wire Size	Cable(mm ²)	Torque value(max)
1KVA/2KVA	1 x 6AWG	14	2 Nm
3KVA	1 x 4AWG	25	
3KVA Plus/5KVA	1 x 2AWG	35	

Please follow below steps to implement battery connection:

1. Remove insulation sleeve 18 mm for positive and negative conductors.
2. Suggest to put bootlace ferrules on the end of positive and negative wires with a proper crimping tool.
3. Fix strain relief plate to the inverter by supplied screws as shown in below chart.

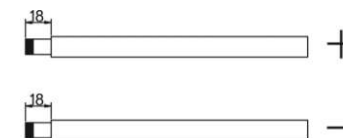

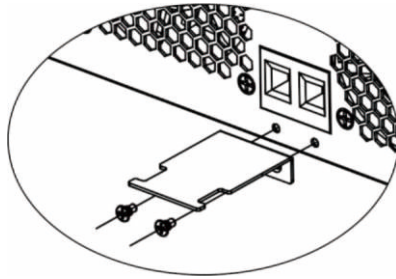

4. 1KVA model supports 12VDC system, 2KVA/3KVA model supports 24VDC system and 5KVA model supports 48VDC system. Connect all battery packs as below chart. It's suggested to connect at least 100Ah capacity battery for 1-3KVA model and at least 200Ah capacity battery for 5KVA model.

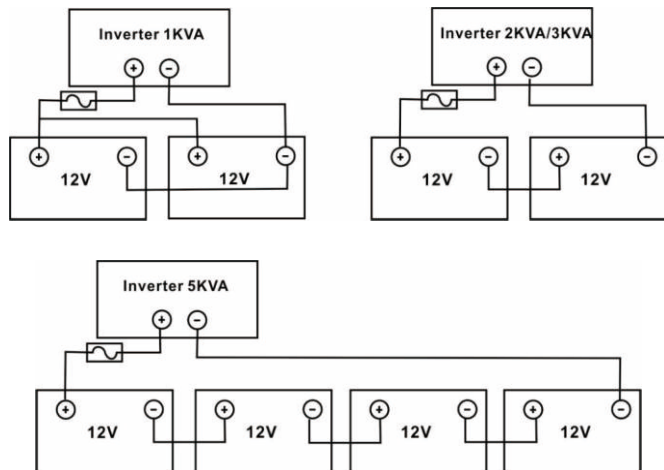

5. Insert the battery wires flatly into battery connectors of inverter and make sure the bolts are tightened with torque of 2 Nm in clockwise direction. Make sure polarity at both the battery and the inverter/charge is correctly connected and conductors are tightly screwed into the battery terminals.

Recommended tool: #2 Pozzi Screwdriver

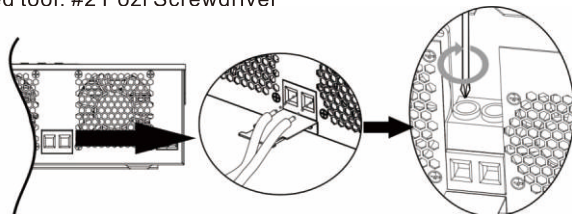

6. To firmly secure wire connection, you may fix the wires to strain relief with cable tie.

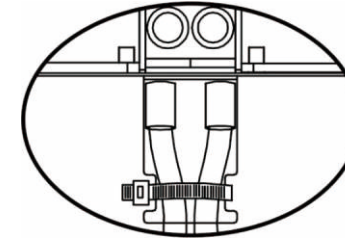

WARNING: Shock Hazard
Installation must be performed with care due to high battery voltage in series.

CAUTION!! Before making the final DC connection or closing DC breaker/disconnector, be sure positive (+) must be connected to positive (+) and negative (-) must be connected to negative (-).

AC Input/Output Connection

CAUTION!! Before connecting to AC input power source, please install a separate AC breaker between inverter and AC input power source. This will ensure the inverter can be securely disconnected during maintenance and fully protected from over current of AC input. The recommended spec of AC breaker is 10A for 1KVA, 20A for 2KVA, 32A for 3KVA/3KVA Plus and 50A for 5KVA.

CAUTION!! There are two terminal blocks with "IN" and "OUT" markings. Please do NOT mis-connect input and output connectors.

WARNING! All wiring must be performed by a qualified personnel.

WARNING! It's very important for system safety and efficient operation to use appropriate cable for AC input connection. To reduce risk of injury, please use the proper recommended cable size as below.

Suggested cable requirement for AC wires

Model	Wire Size	Cable(mm ²)	Torque value(max)
1KVA	16AWG	1.5	0.6 Nm
2KVA	14AWG	2.5	1.0 Nm
3KVA/3KVA Plus	12AWG	4	1.2 Nm
5KVA	10AWG	6	1.2 Nm

Please follow below steps to implement AC input/output connection:

1. Before making AC input/output connection, be sure to open DC protector or disconnector first.
2. Remove insulation sleeve 10mm for six conductors. And shorten phase L and neutral conductor N 3 mm.
3. For 1KVA/2KVA models, simply connect AC utility to AC input of the inverter with a plug. For 3KVA-5KVA models, insert AC input wires according to polarities indicated on terminal block and tighten the terminal screws. Be sure to connect PE protective conductor (⊕) first.

⊕ → Ground (yellow-green) L → LINE (brown or black) N → Neutral (blue)

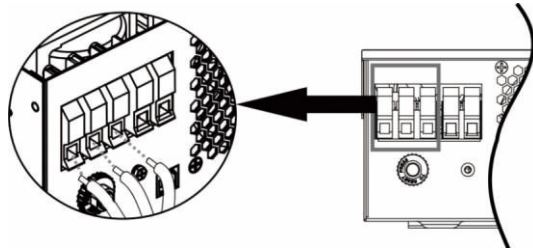

WARNING:
Be sure that AC power source is disconnected before attempting to hardwire it to the unit.

4. Then, insert AC output wires according to polarities indicated on terminal block and tighten terminal screws.

Be sure to connect PE protective conductor(⊕) first.

⊕ → Ground (yellow-green)
L → LINE (brown or black)
N → Neutral (blue)

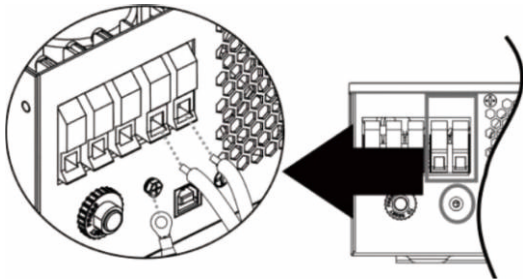

5. Make sure the wires are securely connected.

CAUTION: Appliances such as air conditioner are required at least 2~3 minutes to restart because it's required to have enough time to balance refrigerant gas inside of circuits. If a power shortage occurs and recovers in a short time, it will cause damage to your connected appliances. To prevent this kind of damage, please check manufacturer of air conditioner if it's equipped with time-delay function before installation. Otherwise, this inverter/charger will trig overload fault and cut off output to protect your appliance but sometimes it still causes internal damage to the air conditioner.

PV Connection

CAUTION: Before connecting to PV modules, please install separately a DC circuit breaker between inverter and PV modules.

WARNING! It's very important for system safety and efficient operation to use appropriate cable for PV module connection. To reduce risk of injury, please use the proper recommend cable size as below.

Model	Wire Size	Cable(mm ²)	Torque value(max)
1KVA/2KVA/3KVA 3KVA Plus/5KVA	1 x 8AWG	10	1.6 Nm

PV Module Selection (Only for the model with PWM solar charger)

When selecting proper PV modules, please be sure to consider below requirements first:

1. Open circuit Voltage (Voc) of PV modules not exceeds max. PV array open circuit voltage of inverter.

Charging Current (PWM)	50Amp		
System DC Voltage	12Vdc	24Vdc	48Vdc
Operating Voltage Range	15~18Vdc	15~18Vdc	15~18Vdc
Max. PV Array Open Circuit Voltage	55Vdc	80Vdc	105Vdc

2. Max. Power Voltage (Vmpp) of PV modules should be close to best Vmp of inverter or within Vmp range to get best performance. If one PV module cannot meet this requirement, it's necessary to have several PV modules in series connection.

Maximum PV module numbers in Series: Vmpp of PV module * X pcs = Best Vmp of Inverter or Vmp range

PV module numbers in Parallel: Max. charging current of inverter / Impp

Total PV module numbers = maximum PV module numbers in series * PV module numbers in parallel

Take 1KVA inverter as an example to select proper PV modules. After considering Voc of PV module not exceeds 50Vdc and max. Vmpp of PV module close to 15Vdc or within 13Vdc ~ 18Vdc, we can choose PV module with below specification.

Maximum Power (Pmax)	85W	Max. PV module numbers in series 1 → 17.6 x 1 = 15 ~ 18
Max. Power Voltage Vmpp(V)	17.6V	
Max. Power Current Impp(A)	4.83A	PV module numbers in parallel 10 → 50 A / 4.83 Total PV module numbers 1 x 10 = 10
Open Circuit Voltage Voc(V)	21.6V	
Short Circuit Current Isc(A)	5.03A	

Maximum PV module numbers in Series: 1

PV module numbers in Parallel: 10

Total PV module numbers: 1 x 10 = 10

Take 2KVA/3KVA model inverter as an example to select proper PV module. After considering Voc of PV module not exceed 80Vdc and max. Vmpp of PV module close to 30Vdc or within 30Vdc ~ 32Vdc, we can choose PV module with below specification.

Maximum Power (Pmax)	260W	Max. PV module numbers in series 1 → 30.9 x 1 ≈ 30 ~ 32
Max. Power Voltage Vmpp(V)	30.9V	
Max. Power Current Imp(A)	8.42A	PV module numbers in parallel 6 → 50 A / 8.42 Total PV module numbers 1 x 6 = 6
Open Circuit Voltage Voc(V)	37.7V	
Short Circuit Current Isc(A)	8.89A	

Maximum PV module numbers in Series: 1

PV module numbers in Parallel: 6

Total PV module numbers: 1 x 6 = 6

Take 5KVA model inverter as an example to select proper PV module. After considering Voc of PV module not exceed 105Vdc and max. Vmpp of PV module close to 60Vdc or within 56Vdc ~ 72Vdc, we can choose PV module with below specification.

Maximum Power (Pmax)	260W	Max. PV module numbers in series 2 → 30.9 x 2 ≈ 56 ~ 72
Max. Power Voltage Vmpp(V)	30.9V	
Max. Power Current Imp(A)	8.42A	PV module numbers in parallel 6 → 50 A / 8.42 Total PV module numbers 2 x 6 = 12
Open Circuit Voltage Voc(V)	37.7V	
Short Circuit Current Isc(A)	8.89A	

Maximum PV module numbers in Series: 2

PV module numbers in Parallel: 6

Total PV module numbers: 2 x 6 = 12

PV Module Selection: (Only for the model with MPPT solar charger)

When selecting proper PV modules, please be sure to consider below parameters:

1. Open circuit Voltage (Voc) of PV modules not exceeds max. PV array open circuit voltage of inverter.
2. Open circuit Voltage (Voc) of PV modules should be higher than min. battery voltage.

INVERTER MODEL	3KVA	3KVA Plus	5KVA
Max. PV Array Open Circuit Voltage	102Vdc	145Vdc	
PV Array MPPT Voltage Range	30~80Vdc	30~115Vdc	60~115Vdc

Take 250Wp PV module as an example. After considering above two parameters, the recommended module configurations for 3KVA, 3KVA Plus and 5KVA are listed as below table.

Maximum Power (Pmax)	250W	3KVA: 2 pieces in serial and 2 sets in parallel. 3KVA Plus: • 2 pieces in serial and 3 sets in parallel, or • 3 pieces in serial and 2 sets in parallel. 5KVA: • 2 pieces in serial and 6 sets in parallel, or • 3 pieces in serial and 4 sets in parallel
Max. Power Voltage Vmpp(V)	30.1V	
Max. Power Current Imp(A)	8.3A	
Open Circuit Voltage Voc(V)	37.7V	
Short Circuit Current Isc(A)	8.4A	

PV Module Wire Connection

Please follow below steps to implement PV module connection:

1. Remove insulation sleeve 10 mm for positive and negative conductors.
2. Suggest to put bootlace ferrules on the end of positive and negative wires with a proper crimping tool.

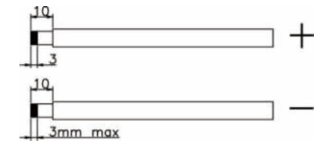

3. Fix strain relief plate to the inverter with supplied screws as shown in below chart.

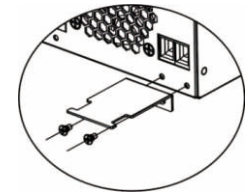

4. Check correct polarity of wire connection from PV modules and PV input connectors. Then, connect positive pole (+) of connection wire to positive pole (+) of PV input connector. Connect negative pole (-) of connection wire to negative pole (-) of PV input connector. Screw two wires tightly in clockwise direction. Recommended tool: 4mm blade screwdriver

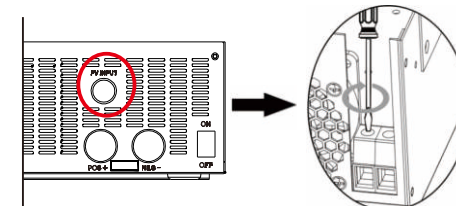

1KVA/2KVA

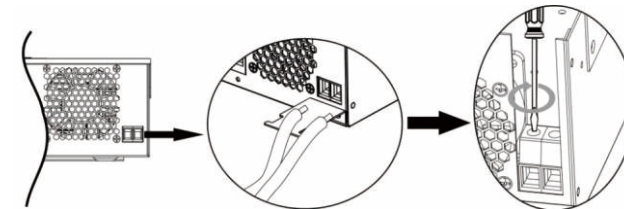

3KVA/5KVA

5. To ensure wires are securely connected, you fix wires to the strain relief with cable tie.

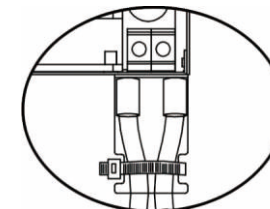

Final Assembly

After connecting all wirings, please put bottom cover back by screwing two screws as shown below.

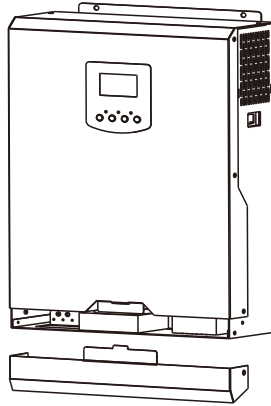

Communication Connection

Please use supplied communication cable to connect to inverter and PC. Insert bundled CD into a computer and follow on-screen instruction to install the monitoring software. For the detailed software operation, please check user manual of software inside of CD.

OPERATION

Power ON/OFF

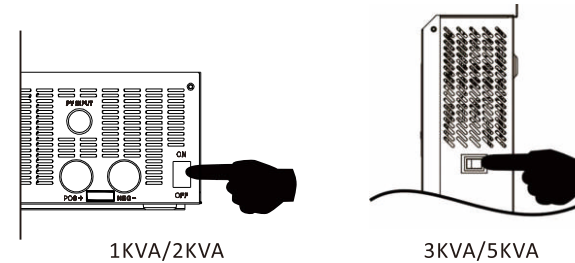

Once the unit has been properly installed and the batteries are connected well, simply press On/Off switch (located on the button of the case) to turn on the unit.

Operation and Display Panel

The operation and display panel, shown in below chart, is on the front panel of the inverter. It includes three indicators, four function keys and a LCD display, indicating the operating status and input/output power information.

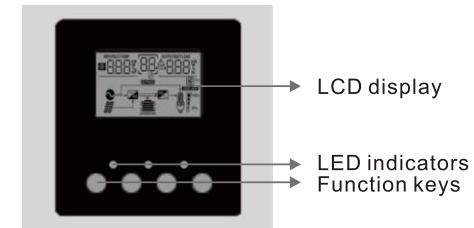

LED Indicator

LED Indicator		Messages	
	Green	Solid On	Output is powered by utility in Line mode.
		Flashing	Output is powered by battery or PV in battery mode.
	Green	Solid On	Battery is fully charged.
		Flashing	Battery is charging.
	Red	Solid On	Fault occurs in the inverter.
		Flashing	Warning condition occurs in the inverter.

Function Keys

Function Key	Description
ESC	To exit setting mode
UP	To go to previous selection
DOWN	To go to next selection
ENTER	To confirm the selection in setting mode or enter setting mode

LCD Display Icons

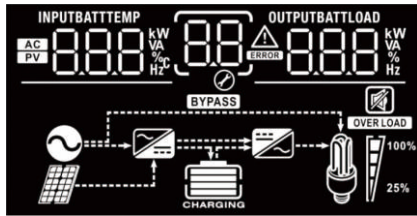

Icon	Function description	
Input Source Information		
	Indicates the AC input.	
	Indicates the PV input	
	Indicate input voltage, input frequency, PV voltage, charger current (if PV in charging for 3K models), charger power (only for MPPT models), battery voltage.	
Configuration Program and Fault Information		
	Indicates the setting programs.	
	Indicates the warning and fault codes. Warning: flashing with warning code. Fault: lighting with fault code	
Output Information		
	Indicate output voltage, output frequency, load percent, load in VA, load in Watt and discharging current.	
Battery Information		
	Indicates battery level by 0-24%, 25-49%, 50-74% and 75-100% in battery mode and charging status in line mode.	
In AC mode, it will present battery charging status.		
Status	Battery voltage	LCD Display
Constant Current mode / Constant Voltage mode	<2V/cell	4 bars will flash in turns.
	2 ~ 2.083V/cell	Bottom bar will be on and the other three bars will flash in turns.
	2.083 ~ 2.167V/cell	Bottom two bars will be on and the other two bars will flash in turns.
	> 2.167 V/cell	Bottom three bars will be on and the top bar will flash.
Floating mode. Batteries are fully charged.		4 bars will be on.

In battery mode, it will present battery capacity.

Load Percentage	Battery Voltage	LCD Display
Load >50%	< 1.85V/cell	
	1.85V/cell ~ 1.933V/cell	
	1.933V/cell ~ 2.017V/cell	
	> 2.017V/cell	
Load < 50%	< 1.892V/cell	
	1.892V/cell ~ 1.975V/cell	
	1.975V/cell ~ 2.058V/cell	
	> 2.058V/cell	

Load Information

	Indicates overload.			
	Indicates the load level by 0-24%, 25-49%, 50-74% and 75-100%.			
	0%~24%	25%~49%	50%~74%	75%~100%

Mode Operation Information

	Indicates unit connects to the mains.
	Indicates unit connects to the PV panel.
	Indicates load is supplied by utility power.
	Indicates the utility charger circuit is working.
	Indicates the DC/AC inverter circuit is working.
Mute Operation	
	Indicates unit alarm is disabled.

LCD Setting

After pressing and holding ENTER button for 3 seconds, the unit will enter setting mode. Press "UP" or "DOWN" button to select setting programs. And then, press "ENTER" button to confirm the selection or ESC button to exit.

Setting Programs:

Program	Description	Selectable option	
00	Exit setting mode	Escape 00 ESC	
01	Output source priority: To configure load power source priority	Solar first 01 SOL	Solar energy provides power to the loads as first priority. If solar energy is not sufficient to power all connected loads, battery energy will supply power to the loads at the same time. Utility provides power to the loads only when any one condition happens: -Solar energy is not available Battery voltage drops to low-level warning voltage or the setting point in program 12.
		Utility first (default) 01 UTI	Utility will provide power to the loads as first priority. Solar and battery energy will provide power to the loads only when utility power is not available.
		SBU priority 01 SBU	Solar energy provides power to the loads as first priority. If solar energy is not sufficient to power all connected loads, battery energy will supply power to the loads at the same time. Utility provides power to the loads only when battery voltage drops to either low-level warning voltage or the setting point in program 12.

02	Maximum charging current: To configure total charging current for solar and utility chargers. (Max. charging current= utility charging current + solar charging current)	Available options in 1KVA-3KVA model:	
		10A 02 10 ^A	20A 02 20 ^A
		30A 02 30 ^A	40A (default for MPPT model) 02 40 ^A
		50A (default for PWM model) 02 50 ^A	60A 02 60 ^A
		70A (only for PWM model) 02 70 ^A	
		Available options in 3KVA Plus/5KVA model:	
		10A 02 10 ^A	20A 02 20 ^A
		30A 02 30 ^A	40A 02 40 ^A
		50A (default for PWM model) 02 50 ^A	60A (default for MPPT model) 02 60 ^A
		70A 02 70 ^A	80A 02 80 ^A
90A 02 90 ^A	100A 02 100 ^A		
110A 02 110 ^A	120A (only for PWM model) 02 120 ^A		
03	AC input voltage range	Appliances (default) 03 APL	If selected, acceptable AC input voltage range will be within 90-280VAC.
		UPS 03 UPS	If selected, acceptable AC input voltage range will be within 170-280VAC.
05	Battery type	AGM (default) 05 AGM	Flooded
		User-Defined 05 USE	If "User-Defined" is selected, battery charge voltage and low DC cut-off voltage can be set up in program 26, 27 and 29.

06	Auto restart when overload occurs	Restart disable (default) 06 LFD	Restart enable 06 LFE
07	Auto restart when over temperature occurs	Restart disable (default) 07 LFD	Restart enable 07 LFE
09	Output frequency	50Hz (default) 09 50 Hz	60Hz 09 60 Hz
11	Maximum utility charging current Note: If setting value in program 02 is smaller than that in program in 11, the inverter will apply charging current from program 02 for utility charger.	Available options in 1KVA/2KVA model:	
		10A 11 10A	20A (default) 11 20A
		Available options in 3KVA model:	
		15A 11 15A	25A (default) 11 25A
		Available options in 3KVA Plus/5KVA model:	
		2A 11 2A	10A 11 10A
		20A 11 20A	30A (default) 11 30A
40A 11 40A	50A 11 50A		
60A 11 60A			
12	Setting voltage point back to utility source when selecting "SBU priority" or "Solar first" in program 01.	Available options in 1KVA model:	
		11.0V 12 11.0V	11.3V 12 11.3V
		11.5V (default) 12 11.5V	11.8V 12 11.8V
		12.0V 12 12.0V	12.3V 12 12.3V
		12.5V 12 12.5V	12.8V 12 12.8V



12	Setting voltage point back to utility source when selecting "SBU priority" or "Solar first" in program 01.	Available options in 2KVA/3KVA/3KVA Plus model:			
		22.0V 12 22.0V	22.5V 12 22.5V		
		23.0V (default) 12 23.0V	23.5V 12 23.5V		
		24.0V 12 24.0V	24.5V 12 24.5V		
		25.0V 12 25.0V	25.5V 12 25.5V		
		Available options in 5KVA model:			
		44.0V 12 44V	45.0V 12 45V		
		46.0V (default) 12 46V	47.0V 12 47V		
		48.0V 12 48V	49.0V 12 49V		
		50.0V 12 50V	51.0V 12 51V		
		13	Setting voltage point back to battery mode when selecting "SBU priority" or "Solar first" in program 01.	Available options in 1KVA model:	
				Battery fully charged 13 FUL	12.0V 13 12.0V
				12.3V 13 12.3V	12.5V 13 12.5V
12.8V 13 12.8V	13.0V 13 13.0V				

13	Setting voltage point back to battery mode when selecting "SBU priority" or "Solar first" in program 01.	Available options in 1KVA model:	
		13.3V 13 ^{BATT} 133v	13.5V (default) 13 ^{BATT} 135v
		13.8V 13 ^{BATT} 138v	14.0V 13 ^{BATT} 140v
		14.3V 13 ^{BATT} 143v	14.5V 13 ^{BATT} 145v
		Available options in 2KVA/3KVA/3KVA Plus model:	
		Battery fully charged 13 ^{BATT} FUL	24V 13 ^{BATT} 240v
		24.5V 13 ^{BATT} 245v	25V 13 ^{BATT} 250v
		25.5V 13 ^{BATT} 255v	26V 13 ^{BATT} 260v
		26.5V 13 ^{BATT} 265v	27V (default) 13 ^{BATT} 270v
		27.5V 13 ^{BATT} 275v	28V 13 ^{BATT} 280v
		28.5V 13 ^{BATT} 285v	29V 13 ^{BATT} 290v
		Available options in 5KVA model:	
		Battery fully charged 13 ^{BATT} FUL	48V 13 ^{BATT} 480v
		49V 13 ^{BATT} 490v	50V 13 ^{BATT} 500v

13	Setting voltage point back to battery mode when selecting "SBU priority" or "Solar first" in program 01.	51V 13 ^{BATT} 510v	52V 13 ^{BATT} 520v
		53V 13 ^{BATT} 530v	54V (default) 13 ^{BATT} 540v
		55V 13 ^{BATT} 550v	56V 13 ^{BATT} 560v
		57V 13 ^{BATT} 570v	58V 13 ^{BATT} 580v
16	Charger source priority: To configure charger source priority	If this inverter/charger is working in Line, Standby or Fault mode, charger source can be programmed as below:	
		Solar first 16 ^{BATT} C50	Solar energy will charge battery as first priority. Utility will charge battery only when solar energy is not available.
		Utility first 16 ^{BATT} CUL	Utility will charge battery as first priority. Solar energy will charge battery only when utility power is not available.
		Solar and Utility (default) 16 ^{BATT} SNU	Solar energy and utility will charge battery at the same time.
		Only Solar 16 ^{BATT} OSO	Solar energy will be the only charger source no matter utility is available or not.
		If this inverter/charger is working in Battery mode or Power saving mode, only solar energy can charge battery. Solar energy will charge battery if it's available and sufficient.	
		18	Alarm control

19	Auto return to default display screen	Return to default display screen (default) 19 ESP	If selected, no matter how users switch display screen, it will automatically return to default display screen (Input voltage /output voltage) after no button is pressed for 1 minute.
		Stay at latest screen 19 FEP	If selected, the display screen will stay at latest screen user finally switches.
20	Backlight control	Backlight on (default) 20 LON	Backlight off 20 LOF
22	Beeps while primary source is interrupted	Alarm on (default) 22 AON	Alarm off 22 AOF
23	Overload bypass: When enabled, the unit will transfer to line mode if overload occurs in battery mode.	Bypass disable (default) 23 BYD	Bypass enable 23 BYE
25	Record Fault code	Record enable (default) 25 FEN	Record disable 25 FDS
26	Bulk charging voltage (C.V voltage)	1KVA default setting: 14.1V CU 26 14.1 ^{BATT}	
		2KVA/3KVA/3KVA Plus default setting: 28.2V CU 26 28.2 ^{BATT}	
		5KVA default setting: 56.4V CU 26 56.4 ^{BATT}	
		If self-defined is selected in program 5, this program can be set up. Setting range is from 12.5V to 15.0V for 1K model, 25.0V to 30.0V for 2KVA model, 25.0V to 31.5V for 3KVA/3KVA Plus model and 48.0V to 61.0V for 5KVA model. Increment of each click is 0.1V.	

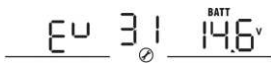
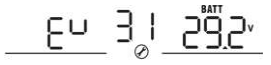
27	Floating charging voltage	1KVA default setting: 13.5V FLU 27 13.5 ^{BATT}	
		3KVA default setting: 27.0V FLU 27 27.0 ^{BATT}	
		5KVA default setting: 54.0V FLU 27 54.0 ^{BATT}	
		If self-defined is selected in program 5, this program can be set up. Setting range is from 12.5V to 15.0V for 1K model, 25.0V to 30.0V for 2KVA model, 25.0V to 31.5V for 3KVA/3KVA Plus model and 48.0V to 61.0V for 5KVA model. Increment of each click is 0.1V.	
29	Low DC cut-off voltage	1KVA default setting: 10.5V COU 29 10.5 ^{BATT}	
		2KVA/3KVA/3KVA Plus default setting: 21.0V COU 29 21.0 ^{BATT}	
		5KVA default setting: 42.0V COU 29 42.0 ^{BATT}	
		If self-defined is selected in program 5, this program can be set up. Setting range is from 10.5V to 12.0V for 1K model, 21.0V to 24.0V for 2KVA/3KVA/3KVA Plus model and 42.0V to 48.0V for 5KVA model. Increment of each click is 0.1V. Low DC cut-off voltage will be fixed to setting value no matter what percentage of load is connected.	
30	Battery equalization	Battery equalization 30 EEN	Battery equalization disable (default) 30 EDS
		If "Flooded" or "User-Defined" is selected in program 05, this program can be set up.	

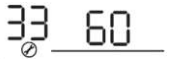
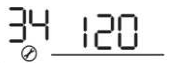
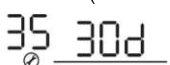
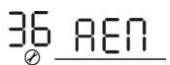
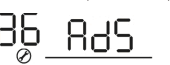
31	Battery equalization voltage	1KVA default setting: 14.6V 	
		2KVA/3KVA/3KVA Plus default setting: 29.2V 	
		5KVA default setting: 58.4V 	
		Setting range is from 12.5V to 15.0V for 1KVA model, 25.0V to 30.0V for 2KVA model, 25.0V to 31.5V for 3KVA /3KVA Plus model and 48.0V to 61.0V for 5KVA model. Increment of each click is 0.1V.	
33	Battery equalized time	60min (default) 	Setting range is from 5min to 900min. Increment of each click is 5min.
34	Battery equalized timeout	120min (default) 	Setting range is from 5min to 900 min. Increment of each click is 5 min.
35	Equalization interval	120min (default) 	Setting range is from 0 to 90 days. Increment of each click is 1 day
36	Equalization activated immediately	Enable 	Disable (default) 
		If equalization function is enabled in program 30, this program can be set up. If "Enable" is selected in this program, it's to activate battery equalization immediately and LCD main page will shows "EQ". If "Disable" is selected, it will cancel equalization function until next activated equalization time arrives based on program 35 setting. At this time, "EQ" will not be shown in LCD main page.	

Display Setting



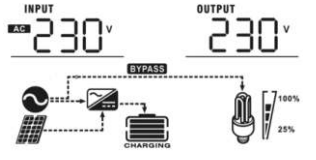
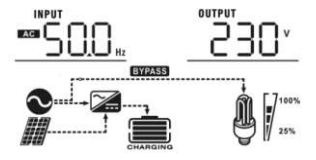
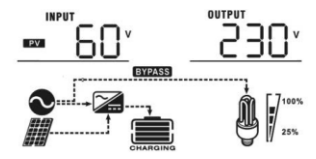
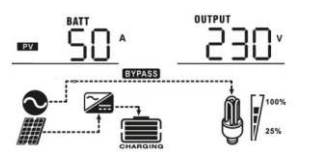
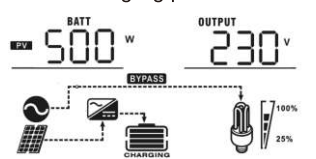
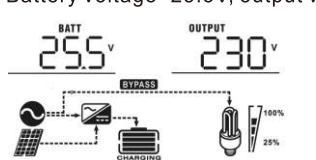





The LCD display information will be switched in turns by pressing "UP" or "DOWN" key. The selectable information is switched as below order: input voltage, input frequency, PV voltage, charging current, charging power (only for MPPT models), battery voltage, output voltage, output frequency, load percentage, load in Watt, load in VA, load in Watt, DC discharging current, main CPU Version and second CPU Version.



Selectable information	LCD display
Input voltage/Output voltage (Default Display Screen)	Input Voltage=230V, output voltage=230V 
Input frequency	Input frequency=50Hz 
PV voltage	PV voltage=60V 
Charging current	Charging current=50A 
Charging power (only for MPPT model)	MPPT charging power=500W 
Battery voltage and output voltage	Battery voltage=25.5V, output voltage=230V 

Selectable information	LCD display
Output frequency	<p>Output frequency=50Hz</p>
Load percentage	<p>Load percent=70%</p>
Load in VA	<p>When connected load is lower than 1kVA, load in VA will present xxxVA like below chart.</p> <p>When load is larger than 1kVA ($\geq 1\text{kVA}$), load in VA will present x.xkVA like below chart.</p>

Selectable information	LCD display
Load in Watt	<p>When load is lower than 1kW, load in W will present xxxW like below chart.</p> <p>When load is larger than 1kW ($\geq 1\text{kW}$), load in W will present x.xkW like below chart.</p>
Battery voltage/DC discharging current	<p>Battery voltage=25.5V, discharging current=1A</p>
Main CPU version checking	<p>Main CPU version 00014.04</p>
Secondary CPU version checking	<p>Secondary CPU version 00003.03</p>

Operating Mode Description

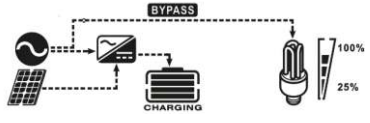
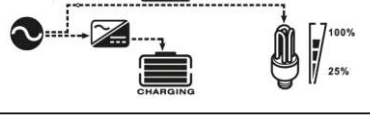
Operation mode	Description	LCD display
Standby mode / Power saving mode Note: *Standby mode: The inverter is not turned on yet but at this time, the inverter can charge battery without AC output. *Power saving mode: If enabled, the output of inverter will be off when connected load is pretty low or not detected.	No output is supplied by the unit but it still can charge batteries.	Charging by utility and PV energy. 
		Charging by utility. 
		Charging by PV energy. 
		No charging. 
Fault mode Note: *Fault mode: Errors are caused by inside circuit error or external reasons such as over temperature, output short circuited and so on.	PV energy and utility can charge batteries.	Charging by utility and PV energy. 
		Charging by utility. 
		Charging by PV energy. 
		No charging. 

Operation mode	Description	LCD display
Line Mode	The unit will provide output power from the mains. It will also charge the battery at line mode.	Charging by utility and PV energy. 
		Charging by utility. 
Battery Mode	The unit will provide output power from battery and PV power.	Power from battery and PV energy. 
		Power from battery only. 

Battery Equalization Description

Equalization function is added into charge controller. It reverses the buildup of negative chemical effects like stratification, a condition where acid concentration is greater at the bottom of the battery than at the top. Equalization also helps to remove sulfate crystals that might have built up on the plates. If left unchecked, this condition, called sulfation, will reduce the overall capacity of the battery. Therefore, it's recommended to equalize battery periodically.

How to Apply Equalization Function

You must enable battery equalization function in monitoring LCD setting program 30 first. Then, you may apply this function in device by either one of following methods:

1. Setting equalization interval in program 35.
2. Active equalization immediately in program 36.

When to Equalize

In float stage, when the setting equalization interval (battery equalization cycle) is arrived, or equalization is active immediately, the controller will start to enter Equalize stage.

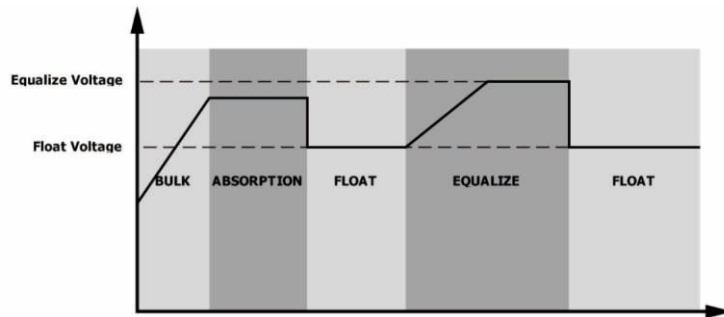

Equalize charging time and timeout



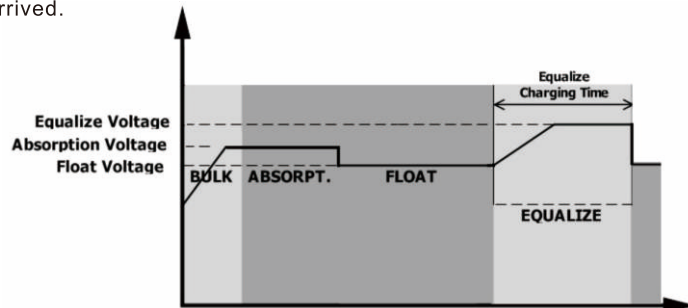



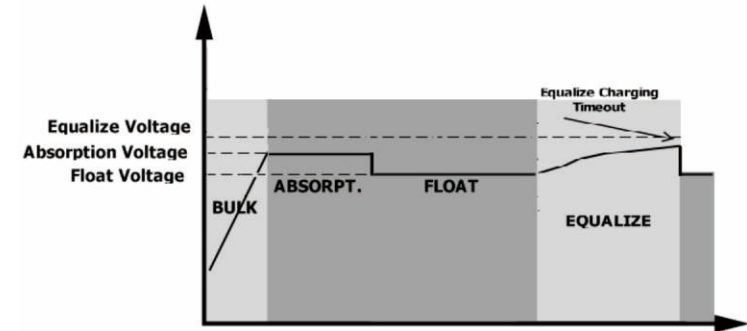









In Equalize stage, the controller will supply power to charge battery as much as possible until battery voltage raises to battery equalization voltage. Then, constant-voltage regulation is applied to maintain battery voltage at the battery equalization voltage. The battery will remain in the Equalize stage until setting battery equalized time is arrived.



However, in Equalize stage, when battery equalized time is expired and battery voltage doesn't rise to battery equalization voltage point, the charge controller will extend the battery equalized time until battery voltage achieves battery equalization voltage. If battery voltage is still lower than battery equalization voltage when battery equalized timeout setting is over, the charge controller will stop equalization and return to float stage.









Fault Reference Code

Fault Code	Fault Event	Icon on
1	Fan is locked when inverter is off.	
2	Over temperature	
3	Battery voltage is too high	
4	Battery voltage is too low	
5	Output short circuited or over temperature is detected by internal converter components.	
6	Output voltage is abnormal. (For 3KVA model) Output voltage is too high. (For 3KVA Plus/5KVA model)	
7	Overload time out	
8	Bus voltage is too high	
9	Bus soft start failed	
51	Over current or surge	
52	Bus voltage is too low	
53	Inverter soft start failed	
55	Over DC voltage in AC output	
56	Battery connection is open	
57	Current sensor failed	
58	Output voltage is too low	

NOTE: Fault codes 51, 52, 53, 55, 56, 57 and 58 are only available in 3KVA Plus /5KVA model.

Warning Indicator

Warning Code	Warning Event	Audible Alarm	Icon flashing
01	Fan is locked when inverter is on.	Beep three times every second	
03	Battery is over-charged	Beep once every second	
04	Low battery	Beep once every second	
07	Overload	Beep once every 0.5 second	
10	Output power derating	Beep twice every 3 seconds	
E9	Battery equalization	None	

SPECIFICATIONS

Table 1 Line Mode Specifications

INVERTER MODEL	1KVA	2KVA	3KVA	3KVA Plus	5KVA
Input Voltage Waveform	Sinusoidal (utility or generator)				
Nominal Input Voltage	230Vac				
Low Loss Voltage	170Vac±7V (UPS); 90Vac±7V (Appliances)				
Low Loss Return Voltage	180Vac±7V (UPS); 100Vac±7V (Appliances)				
High Loss Voltage	280Vac±7V				
High Loss Return Voltage	270Vac±7V				
Max AC Input Voltage	300Vac				
Nominal Input Frequency	50Hz / 60Hz (Auto detection)				
Low Loss Frequency	40±1Hz				
Low Loss Return Frequency	42±1Hz				
High Loss Frequency	65±1Hz				
High Loss Return Frequency	63±1Hz				
Output Short Circuit Protection	Circuit Breaker				
Efficiency (Line Mode)	>95% (Rated R load, battery full charged)				
Transfer Time	10ms typical (UPS); 20ms typical (Appliances)				
Output power derating: When AC input voltage drops to 170V, the output power will be derated.					

Table 2 Inverter Mode Specifications

INVERTER MODEL	1KVA	2KVA	3KVA	3KVA Plus	5KVA
Rated Output Power	1KVA/1KW	2KVA/2KW	3KVA/3KW		5KVA/5KW
Output Voltage Waveform	Pure Sine Wave				
Output Voltage Regulation	230Vac±5%				
Output Frequency	50Hz				
Peak Efficiency	93%				
Overload Protection	5s@≥150% load; 10s@105%~150% load				
Surge Capacity	2* rated power for 5 seconds				
Nominal DC Input Voltage	12Vdc	24Vdc	24Vdc		48Vdc
Cold Start Voltage	11.5Vdc	23.0Vdc	23.0Vdc		46.0Vdc
Low DC Warning Voltage					
@ load < 50%	11.5Vdc	23.0Vdc	23.0Vdc		47.0Vdc
@ load ≥ 50%	11.0Vdc	22.0Vdc	22.0Vdc		46.0Vdc
Low DC Warning Return Voltage					
@ load < 50%	11.7Vdc	23.5Vdc	23.5Vdc		47.0Vdc
@ load ≥ 50%	11.5Vdc	23.0Vdc	23.0Vdc		46.0Vdc
Low DC Cut-off Voltage					
@ load < 50%	10.7Vdc	21.5Vdc	21.5Vdc		43.0Vdc
@ load ≥ 50%	10.5Vdc	21.0Vdc	21.0Vdc		42.0Vdc
High DC Recovery Voltage	15Vdc	30Vdc	32Vdc		62Vdc
High DC Cut-off Voltage	16Vdc	31Vdc	33Vdc		63Vdc
No Load Power Consumption	<25W				<55W

Table 3 Charge Mode Specifications

Utility Charging Mode					
INVERTER MODEL	1KVA	2KVA	3KVA	3KVA Plus	5KVA
Charging Algorithm	3-Step				
AC Charging Current (Max)	20Amp (@VI/P=230Vac)	25Amp (@VI/P=230Vac)	60Amp (@VI/P=230Vac)		
Bulk Charging	Flooded Battery	14.6	29.2		58.4
Voltage	AGM / Gel Battery	14.1	28.2		56.4
Floating Charging Voltage		13.5Vdc	27Vdc		54Vdc
Charging Curve	<p>The graph shows Battery Voltage (per cell) on the left y-axis and Charging Current (%) on the right y-axis against Time on the x-axis. The voltage curve (black) rises linearly in the Bulk stage, levels off in the Absorption stage, and remains constant in the Maintenance stage. The current curve (red) is constant in the Bulk stage, drops to zero in the Absorption stage, and remains at zero in the Maintenance stage. Key points on the voltage curve include 14.4V (230Vdc) and 14.6V (230Vdc). Time intervals T1 and T2 are marked.</p>				
PWM Solar Charging Mode					
INVERTER MODEL	1KVA	2KVA	3KVA	5KVA	
Charging Current	50Amp				
System DC Voltage	12Vdc	24Vdc	48Vdc		
Operating Voltage Range	15-18Vdc	30-32Vdc	60-72Vdc		
Max. PV Array Open Circuit Voltage	55Vdc	80Vdc	105Vdc		
DC Voltage Accuracy	±0.3%				
Max Charging Current (AC charger plus solar charger)	50Amp	70Amp	110Amp		
MPPT Solar Charging Mode					
INVERTER MODEL	3KVA		3KVA Plus	5KVA	
Charging Current	40Amp		60Amp	60Amp	
PV Array MPPT Voltage Range	30-80Vdc		30-115Vdc	60-115Vdc	
Max. PV Array Open Circuit Voltage	102Vdc		145Vdc		
Max Charging Current (AC charger plus solar charger)	60Amp		120Amp		

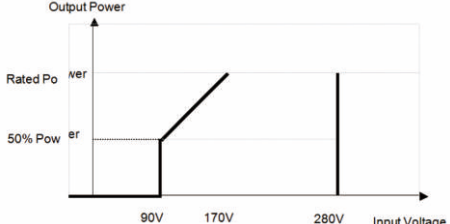
Table 4 General Specifications

INVERTER MODEL	1KVA	2KVA	3KVA	3KVA Plus	5KVA
Safety Certification	CE				
Operating Temperature Range	-10°C to 50°C				
Storage temperature	-15°C~ 60°C				
Humidity	5% to 95% Relative Humidity (Non-condensing)				
Dimension (D*W*H), mm	88*225*320		100*285*334	100*300*440	
Net Weight, kg (PWM model)	5.0	5.5	6.3	N/A	8.5
Net Weight, kg (MPPT model)	N/A	N/A	6.5	9.5	9.7

TROUBLE SHOOTING

Problem	LCD/LED/Buzzer	Explanation / Possible cause	Problem
Unit shuts down automatically during startup process	LCD/LEDs and buzzer will be active for 3 seconds and then complete off	The battery voltage is too low (<1.91V/Cell)	1. Re-charge battery. 2. Replace battery.
No response after power on	No indication	1. The battery voltage is far too low. (<1.4V/Cell) 2. Internal fuse tripped	1. Contact repair center for replacing the fuse 2. Re-charge battery 3. Replace battery
Mains exist but the unit works in battery mode.	Input voltage is displayed as 0 on the LCD and green LED is flashing	Input protector is tripped	Check if AC breaker is tripped and AC wiring is connected well
	Green LED is flashing	Insufficient quality of AC power. (Shore or Generator)	1. Check if AC wires are too thin and/or too long. 2. Check if generator (if applied) is working well or if input voltage range setting is correct. (UPS →Appliance)
	Green LED is flashing	Set "Solar First" as the priority of output source	Change output source priority to Utility first

Problem	LCD/LED/Buzzer	Explanation / Possible cause	Problem
When the unit is turned on, internal relay is switched on and off repeatedly	LCD display and LEDs are flashing	Battery is disconnected	Check if battery wires are connected well
Buzzer beeps continuously and red LED is on	Fault code 07	Overload error. The inverter is overload 105% and time is up	Reduce the connected load by switching off some equipment
	Fault code 05	Output short circuited	Check if wiring is connected well and remove abnormal load
		Temperature of internal converter component is over 120°C. (Only available for 1-3KVA models)	Check whether the air flow of the unit is blocked or whether the ambient temperature is too high
	Fault code 02	Internal temperature of inverter component is over 100°C	
	Fault code 03	Battery is over-charged	Return to repair center
		The battery voltage is too high	Check if spec and quantity of batteries are meet requirements
	Fault code 01	Fan fault	Replace the fan
	Fault code 06/58	Output abnormal (Inverter voltage below than 190Vac or is higher than 260Vac)	1. Reduce the connected load. 2. Return to repair center
	Fault code 08/09/53/57	Internal components failed	Return to repair center
	Fault code 51	Over current or surge	Restart the unit, if the error happens again, please return to repair center
Fault code 52	Bus voltage is too low		
Fault code 55	Output voltage is unbalanced		
Fault code 56	PV input voltage is beyond the specification	Reduce the number of pv modules in series	