

## Instruction for Solar Pump Controller

### I. Attention:

Before powering on the controller, please check the open-circuit voltage of the solar panel, which is forbidden to exceed the allowable maximum input voltage of the controller. Otherwise, product damage will occur.

<b>Limits table of Solar Panel's Max Open-Circuit Voltage</b>						
Specified voltage DC(V)	24	36	48	72	96	110
Max Open- Circuit Voltage DC(V)	50	50	100	150	150	200

### II. Wiring Schematic Diagram

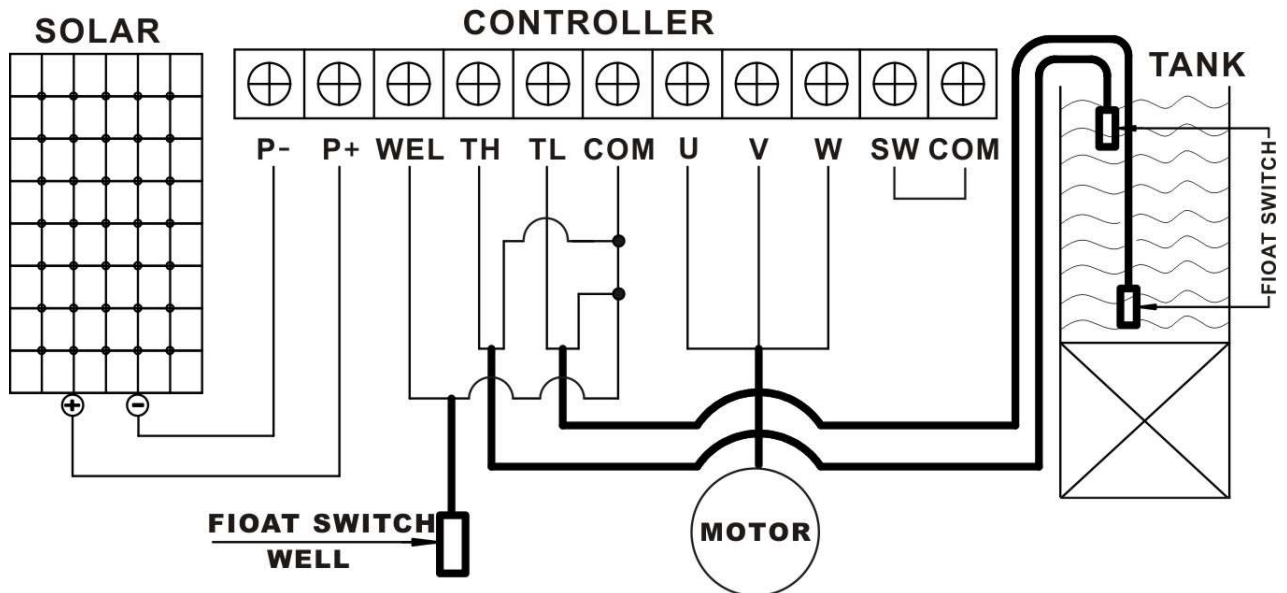

Note: Some models don't have two terminals of SW and COM.

### III. Working Environment Requirements

1. The Temperature should range from -15°C to 60°C

2. The RH (relative air humidity) should range from 20% to 90%.

3. Protective measures against rain and sun are required.







#### IV. Operation Panel



##### 1. LED Light

- Light for Voltage (V): In voltage display mode, the light is on. Otherwise the light is off.
- Light for Rotating speed (RPM): In rotating speed display mode, the light is on. Otherwise the light is off.
- Light for Current (A): In current display mode, the light is on. Otherwise the light is off.
- Light for Power (W): In power display mode, the light is on. Otherwise the light is off.
- Light for the Full Tank (Tank): When the tank is full of water, the light is on. Otherwise the light is off.
- Light for Water Shortage in Well (Well): When the well is lack of water, the light is on. Otherwise the light is off.
- Light for Solar Mode (MMPT): When the pump is working with solar power, the light is on. Otherwise the light is off.
- Light for Power Supply and Operation (Power) : When the pump stops working, the light flickers. Otherwise the light is on.

##### 2. Keys Operation

Key's Name	Function
 Set Key	<ul style="list-style-type: none"> <li>• The parameter is set by the manufacturer and it is out of service.</li> </ul>
 Enter Key	<ul style="list-style-type: none"> <li>• The parameter is set by the manufacturer and it is out of service.</li> </ul>
 Up Key	<ul style="list-style-type: none"> <li>• The parameter is set by the manufacturer and it is out of service.</li> </ul>
 Down Key	<ul style="list-style-type: none"> <li>• The parameter is set by the manufacturer and it is out of service.</li> </ul>
 Switch Key	<ul style="list-style-type: none"> <li>• When the pump is working, the key is used to change the display mode. Once the key is pressed, the mode could be changed according to the sequence of Voltage (V) to Revolution speed (RPM) to Current (A) to Power (W) circularly.</li> </ul>
 On-Off Key	<ul style="list-style-type: none"> <li>• When the pump is working, press the key for 5 seconds to power off the pump.</li> <li>• When the pump is not working, press the key for 5 seconds to turn on the pump.</li> </ul>

#### VI. System Debug

##### 1. Confirm the Rotating Direction

Connect with the power before use and press the On-Off key for several times to check whether the pump is work normally with its rotor rotating in right direction. (Long time dry running is forbidden) If a three phase pump rotates in a wrong direction, you only need to exchange any two of power supply input wires.

##### 2. On-Off Control of the Pump

### 1) Controlled by Float Switch

When working normally, the pump will shut down immediately if the tank light is on, which means the tank is full of water and the upper float switch in the tank has been closed. And if there is no enough water in the tank, the nether float switch in the tank will close and thereby the pump will turn on promptly. Besides, if the float switch in the well close, which means there is no enough water in the well, the well light will be on and then the pump will also shut down. The system will detect the status of the float switch and restart the pump 20 minutes later.

### 2) Triggered off by Water Shortage.

When the pump has been working for a while and its present power is lower than the rated power at current speed for 20 seconds, it will shut down immediately. The pump will restart once the power is higher than the rated one.

### 3) Controlled by Key

Press the  to start or close the pump.

### 3. Operation Mode of Pump

Every time the pump starts, it will identify which power supply mode it is in, (DC or PV) . This procedure will last for 10 seconds and after that the pump will switch to the corresponding mode to work.

#### 1) DC Mode (Battery)

In the DC mode, the supply voltage will keep dropping. In order to avoid over discharge, the pump will shut down when the voltage is lower than the corresponding guard voltage.

#### 2) PV Mode

In the PV mode, the RPM setting is similar to DC mode. RPM is also determined by the current solar panel power. The system tracks the maximum power of the solar panel (MPPT) in real time. When the sunshine is intensified, the output of the panel increases, the rotating speed also increases. Otherwise, both will go down. In the PV mode, the MPPT light flickers. The faster the flicker is, the closer to the maximum working efficiency it will be; If the flicker is slower or even stop, the maximum power point is being tracked. If the power of the solar panel is not enough, the rotating speed will continue to drop. When the speed drops to the set point, the pump will shut down. Where after, the pump will detect the power repeatedly and try to restart again. Solar power is insufficient to maintain the starting or working, and the output voltage of solar panel will drop rapidly, when the output voltage is lower than the set point and lasting more than 10 seconds, it will shut down immediately, then detect the power repeatedly and try to restart again

### 4. Reserve Function for Protection

If the positive and negative poles are connected reversely, the pump will not work. You only need to exchange these two wires.